

## BELSPOT-LIFT 600 DEPOSITOR

Innovation in depositing

Beldos offers a range of versatile volumetric stainless steel depositors with optional attachments for depositing, injection, layering and decoration. Beldos depositors will replace your pastry bag, spoon or a measuring cup and will become the most reliable, easy-to-use and intelligent equipment at your production!

### 1. The Belspot-lift 600 is available in one series:

- 600 – 20-600 ml per deposit;

### 2. Design features:

- mounted on a mobile frame pneumatically adjustable in height for easy changing of mixing bowls and buckets;
- turn-over system for easy removal of mixing bowls;



- it pumps products directly from a mixing bowl or a bucket and allows quick clean-up for work with different products;
- the depositing volume is indicated on a scale from 10% till 100% depending on the product cylinder volume;
- the speed of depositing can be easily adjustable;
- foot pedal operation or handgun operation; press the foot pedal or the trigger of the handgun once for single portion control or hold for multiple deposits;

### 3. Technical specifications







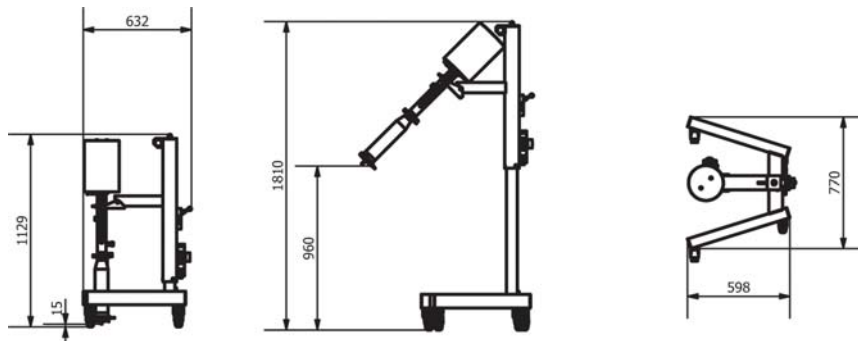









Depositing speed	Up to 120 deposits/min
Power	Air: 98 l/min at 30 deposits/min 7 Bar / 102 PSI
Depositing volume	20-600 cm <sup>3</sup>
Material	Stainless steel



### 4. Dimensions



### 5. Options

<p>Support tray for mixing bowls/buckets</p> 	<p>Balancer for handgun nozzles</p> 	<p>Product cylinder+piston, for different deposit volumes</p> 	<p>Product cylinder size chart</p> <table border="1" data-bbox="1021 459 1468 616"> <thead> <tr> <th rowspan="2">Cylinder size, Ø, mm</th> <th colspan="2">Deposit volume (cm<sup>3</sup>)</th> </tr> <tr> <th>min</th> <th>max</th> </tr> </thead> <tbody> <tr> <td>38,1</td> <td>20</td> <td>251</td> </tr> <tr> <td>76,2</td> <td>100</td> <td>600</td> </tr> </tbody> </table>			Cylinder size, Ø, mm	Deposit volume (cm <sup>3</sup> )		min	max	38,1	20	251	76,2	100	600
Cylinder size, Ø, mm	Deposit volume (cm <sup>3</sup> )															
	min	max														
38,1	20	251														
76,2	100	600														
<p>Extension tubes for nozzles</p>  	<p>Handgun nozzle, for liquid, semi-liquid products, soft paste, heavy paste, aerated products</p>  	<p>Vertical nozzle, for liquid, semi-liquid products, soft paste, heavy paste, aerated products</p>  	<p>Double injection/fill attachment, to attach injection needles/pastry tips/tubes</p>  	<p>Filling tube attachment</p>  												
<p>Injection needle attachment</p>  	<p>Spreader &amp; icing attachments, straight or 45°</p>  	<p>Pastry tips 9 pcs; to attach to Beldos nozzles with thread;</p>  	<p>Spare parts kit (a set for 1 month is included for free)</p> 	<p>Compressors</p> 												

**6. Common applications with additional options:**

- ONLY flowable products: liquid/semi-liquid products, soft paste, aerated products;
- small product cylinder - without particles; big product cylinder - with particles or without (nuts, raisins, pieces of fruit); particle size: max Ø 2,5 cm;

**a. Single depositing (semi-automatic)**



fruit filling



muffins



custard



cherry filling



yogurt

**b. Injection (semi-automatic)**



berliners



éclairs



profiteroles



horns with cheese sauce

**c. Single layering (semi-automatic)**



custard



sandwiches

**d. Multi layering (semi-automatic)**



mousse dessert



mousse dessert



tiramisu

**e. Decoration (semi-automatic)**



stars