

BELCON 1340 DEPOSITOR

Perfect for conveyor

Beldos offers a range of versatile volumetric stainless steel depositors with optional attachments for depositing, injection, layering and decoration. Beldos depositors will replace your pastry bag, spoon or a measuring cup and will become the most reliable, easy-to-use and intelligent equipment at your production!

1. The Belcon depositor is available in three series:

- 275 – 5-275 ml per deposit;
- 670 – 5-670 ml per deposit;
- 1340 - 5-1340 ml per deposit;

2. Design features:

- designed for production lines;
- mounted on a mobile heavy duty frame manually adjustable in height;
- height adjustment feet for horizontal leveling at the conveyor;
- optional locating bracket for blocking the depositor always on the right position at the conveyor belt;
- 60 l hopper;
- the depositing volume is indicated on a scale from 10% till 100% depending on the product cylinder volume;
- the speed of depositing can be easily adjustable;
- foot pedal operation or handgun operation or automatic sensor operation on the conveyor; press the foot pedal or the trigger of the handgun once for single portion control or hold for multiple deposits;

3. Technical specifications

Depositing speed	Up to 120 deposits/min
Power	Air: 219 l/min at 30 deposits/min 7 Bar / 102 PSI
Depositing volume	5-1340 cm ³
Material	Stainless steel



4. Dimensions

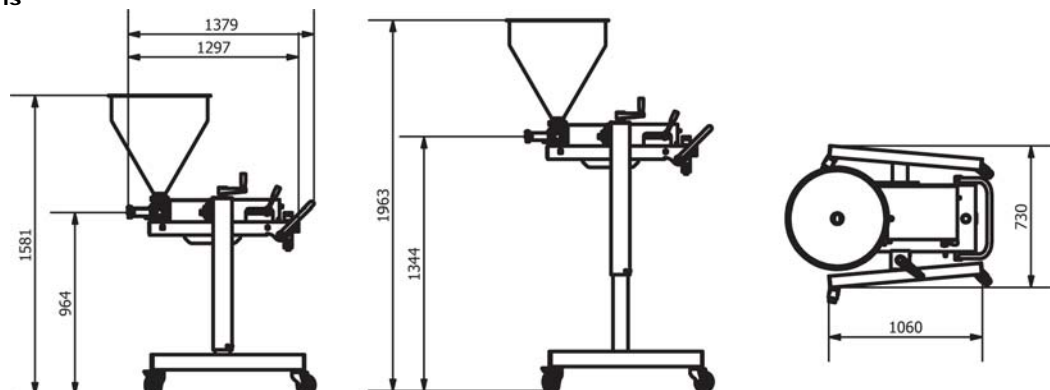





































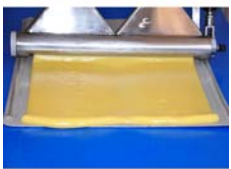



Beldos N.V., Kruiningenstraat 93/95, B-2900, Schoten, Antwerp province, Belgium





Phone: +32 3 646 40 48 Fax: +32 3 646 42 46

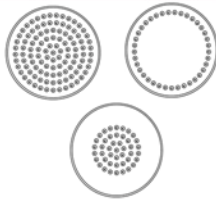

www.beldos.be Email: info@beldos.be

Publisher: Beldos N.V. Without permission of the publisher nothing from this folder can be copied. © 01.01.2011

5. Options																								
<p>Locating bracket for the right position at the conveyor belt</p> 	<p>Balancer for handgun nozzles</p> 	<p>Height adjustable table</p> 	<p>Guide systems for round/rectangular forms</p> 	<p>Product cylinder+piston, for different deposit volumes</p> 																				
<p>Product cylinder size chart</p> <table border="1"> <thead> <tr> <th rowspan="2">Cylinder size, Ø, mm</th> <th colspan="2">Deposit volume (cm³)</th> </tr> <tr> <th>min</th> <th>max</th> </tr> </thead> <tbody> <tr> <td>28</td> <td>5</td> <td>120</td> </tr> <tr> <td>40</td> <td>10</td> <td>280</td> </tr> <tr> <td>52</td> <td>30</td> <td>480</td> </tr> <tr> <td>70</td> <td>100</td> <td>860</td> </tr> <tr> <td>85</td> <td>200</td> <td>1340</td> </tr> </tbody> </table>		Cylinder size, Ø, mm	Deposit volume (cm ³)		min	max	28	5	120	40	10	280	52	30	480	70	100	860	85	200	1340	<p>Rotation cylinders, for different product temperatures</p> 	<p>Conical hoppers, 25/60 l, for flowable products</p> 	<p>Vertical hoppers 25/60 l, for heavy products</p> 
Cylinder size, Ø, mm	Deposit volume (cm ³)																							
	min	max																						
28	5	120																						
40	10	280																						
52	30	480																						
70	100	860																						
85	200	1340																						
<p>Heating jackets, till +120°C</p> 	<p>Follower plates, synthetic, for heavy and aerated products</p> 	<p>Follower plates, stainless steel, to use on follower plate synthetic; for very heavy products</p> 	<p>Hopper division; removable; to deposit two different flavors from one nozzle outlet (marble cake, etc.)</p> 	<p>Stirrer single system, to mix well products</p> 																				
<p>Extension tubes for nozzles</p> 	<p>Nozzle 90°, for soft, heavy paste, aerated products</p> 	<p>Handgun nozzle, for liquid, semi-liquid products, soft paste, heavy paste, aerated products</p> 	<p>Rotary cut-off nozzle, for semi-liquid products, soft paste, heavy paste, aerated products</p> 	<p>Horizontal nozzle, for soft, heavy paste, aerated products</p> 																				

<p>Injection nozzle single, for semi-liquid products, soft paste, aerated products</p>  	<p>Injection nozzle double, for semi-liquid products, soft paste, aerated products</p>  	<p>Vertical nozzle, for liquid, semi-liquid products, soft paste, heavy paste, aerated products</p>  	<p>Diving nozzle, for soft paste, heavy paste, aerated products</p>  	<p>Sheet icing nozzle, for semi-liquid products, soft paste, heavy paste, aerated products</p>  
<p>Multi 2/3/4 system (automatic multi dosing system)</p>  	<p>Double injection/fill attachment, to attach injection needles/pastry tips/tubes</p>  	<p>Filling tube attachment</p>  	<p>Injection needle attachment</p>  	<p>Spreader & icing attachments, straight or 45°</p>  
<p>Pastry tips 9 pcs; to attach to Beldos nozzles with thread;</p> 	<p>Cream cover head attachments, star & plain tips</p>  	<p>Twisted rosettes head attachments</p>  		

<p>Foot pedal, press once for single portion control or hold for multiple deposits</p> 	<p>Manual switch with spring, to use instead of the foot pedal</p> 	<p>Automatic countdown system, system will automatically count down the number of deposits</p> 	<p>Continuous dosing system, the depositor will run automatically</p> 	<p>Sensor, to activate depositor automatically</p> 
--	--	--	--	--

<p>Spare parts kit (a set for 1 month is included for free)</p> 	<p>Compressors</p> 	<p>Conveyor solutions on request</p> 		
--	---	--	--	--

6. Common applications with additional options:

- liquid/semi-liquid products, soft & heavy paste, aerated products;
- anything that can be squeezed through a pastry bag;
- with or without particles (nuts, raisins, pieces of fruit); particle size: max Ø 2,5 cm;

a. Single depositing (1 nozzle, semi-automatic or automatic on conveyor)



fruit filling



muffins



sponge cake

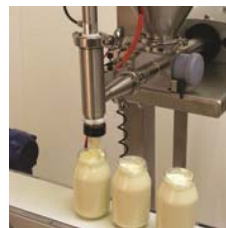

mayonnaise



ready meals

b. Multi depositing (2-4 nozzles, automatic on conveyor)



apple filling



mini-cakes



muffins

c. Injection (semi-automatic)



berliners



éclairs



profiteroles



horns with
cheese sauce



éclairs

d. Single layering (semi-automatic or automatic on conveyor)



custard

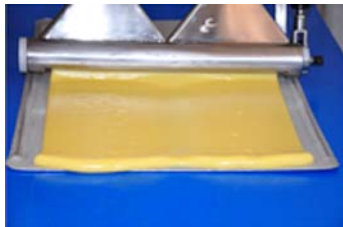

sponge



sandwiches

e. Multi layering (semi-automatic or automatic on conveyor)



mousse dessert



mousse dessert



tiramisu



lasagna

f. Icing of cakes and flans (round/rectangular/square)



mid layer icing

g. Decoration (according to your needs)



cake border



rosettes



stars