

BELGUN SYRUP 275 DEPOSITOR

Clean and even syrup spraying

The Belgun Syrup 275 depositor is designed for semi-automatic portion controlled spraying of liquid products on cake layers of different diameters and forms by use of a handgun with a syrup spraying nozzle. Typically used products are flavoured liquids or simple syrups.

1. Two syrup spraying systems are available:

- Belgun Syrup 275 depositor – 5-275 ml per deposit (semi-automatic system);
- Belsyrup 275 spraying system – 5-275 ml per deposit (automatic system on conveyor);

2. Design features:

- mounted on a low non-adjustable in height mobile frame for easy filling of the hopper;
- 25 l hopper;
- the spraying volume is indicated on a scale from 10% till 100% depending on the product cylinder volume;
- the speed of spraying can be easily adjustable;
- handgun operation only; press the trigger of the handgun once for single spraying control or hold for multiple spraying;







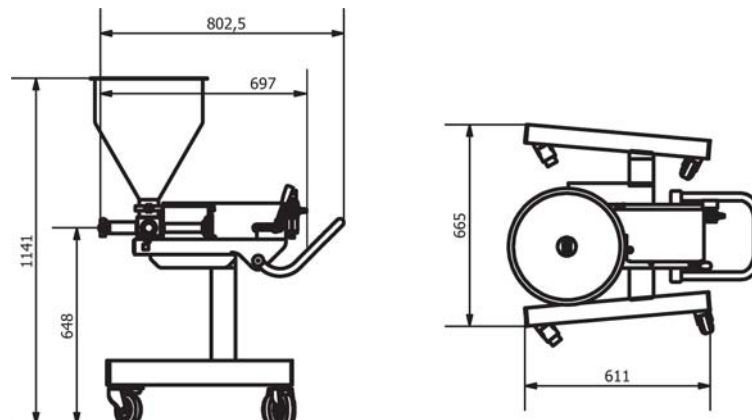

3. Technical specifications

Depositing speed	Up to 120 deposits/min
Power	Air: 29 l/min at 30 deposits/min 7 Bar / 102 PSI
Depositing volume	5-275 cm ³
Material	Stainless steel



4. Dimensions



5. Options																					
<p>Balancer for handgun nozzles</p> 	<p>Product cylinder + piston, for different deposit volumes</p> 	<p>Product cylinder size chart</p> <table border="1"> <thead> <tr> <th rowspan="2">Cylinder size, Ø, mm</th> <th colspan="2">Deposit volume (cm³)</th> </tr> <tr> <th>min</th> <th>max</th> </tr> </thead> <tbody> <tr> <td>28</td> <td>5</td> <td>40</td> </tr> <tr> <td>40</td> <td>10</td> <td>86</td> </tr> <tr> <td>52</td> <td>30</td> <td>151</td> </tr> <tr> <td>70</td> <td>100</td> <td>275</td> </tr> </tbody> </table>		Cylinder size, Ø, mm	Deposit volume (cm ³)		min	max	28	5	40	40	10	86	52	30	151	70	100	275	<p>Rotation cylinders, for different product temperatures</p> 
Cylinder size, Ø, mm	Deposit volume (cm ³)																				
	min	max																			
28	5	40																			
40	10	86																			
52	30	151																			
70	100	275																			
<p>Conical hopper, 25 l</p> 	<p>Handgun nozzle</p> 	<p>Spraying nozzle holder, set of 3 spraying nozzles, to use for different viscosities of syrup</p> 	<p>Spare parts kit (a set for 1 month is included for free)</p> 	<p>Compressors</p> 																	

6. Common applications with additional options:

- spraying of syrup or flavored liquids on cakes of different dimensions and shapes;

a. Syrup spraying (semi-automatic)



syrup spraying